

SK NÁVOD NA MONTÁŽ
 CZ MONTÁŽNÍ NÁVOD
 HU SZERELÉSI UTASÍTÁS
 DE MONTAGEANLEITUNG

INVITA TYP 5

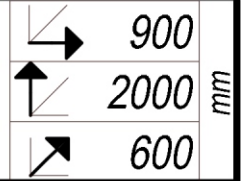

ID	ID	Part	Qty	Order
11603	2	2000*580*16	1x	1/3
11583	3	868*579*16	3x	2/3
11585	4	868*80*16	2x	2/3
11604	5	2000*580*16	1x	1/3
11620	6	1914*446*2,5	2x	1/3
11605	7	1498*438*16	1x	3/3
11606	8	1498*438*16	1x	3/3
11607	9	880*205*16	2x	2/3
11660	10	430*120*16	2x	2/3
11608	11	828*100*16	2x	2/3
11661	12	430*120*16	2x	2/3
11609	13	436*838*2,5	2x	2/3
11674	14	868*574*16	2x	1/3
11674	14	868*574*16	1x	2/3

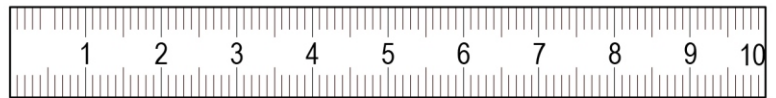
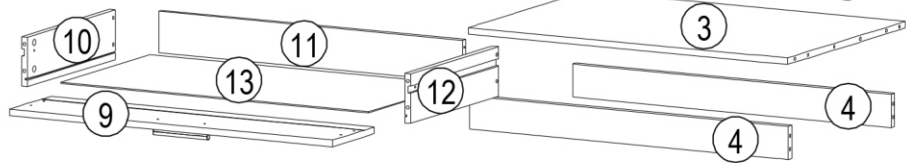
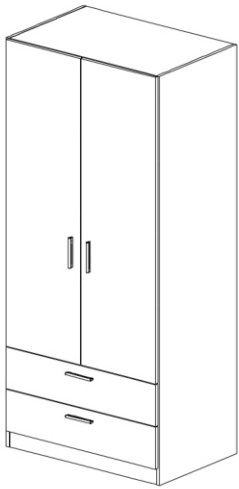
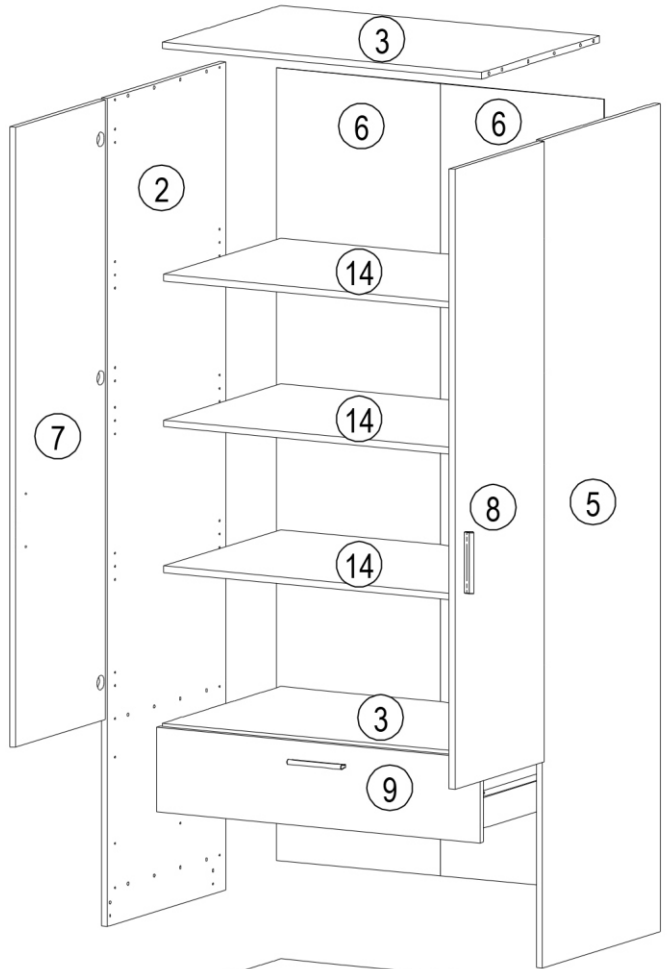

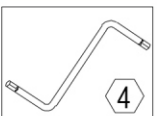

22243,00 A 12x Ø3,5x15	27000,00 B 28x Ø8x30	35101,01 C 12x	70013,01 D 24x	70021,01 E 24x	30090,00 F 8x	21102,00 G 75x Ø1,2x20	31103,00 H 1x	22244,01 J 16x Ø3,5x16	24103,00 K 1x Ø8
22213,00 L 1x Ø4x70	M 12x	32030,00 N 4x	36013,02 P 6x	36013,02 Q 6x	R 8x	22300,00 S 8x Ø7x50	22502,00 T 4x M4x12	22705,00 U 8x Ø6,3x8	33018,00 V 2x



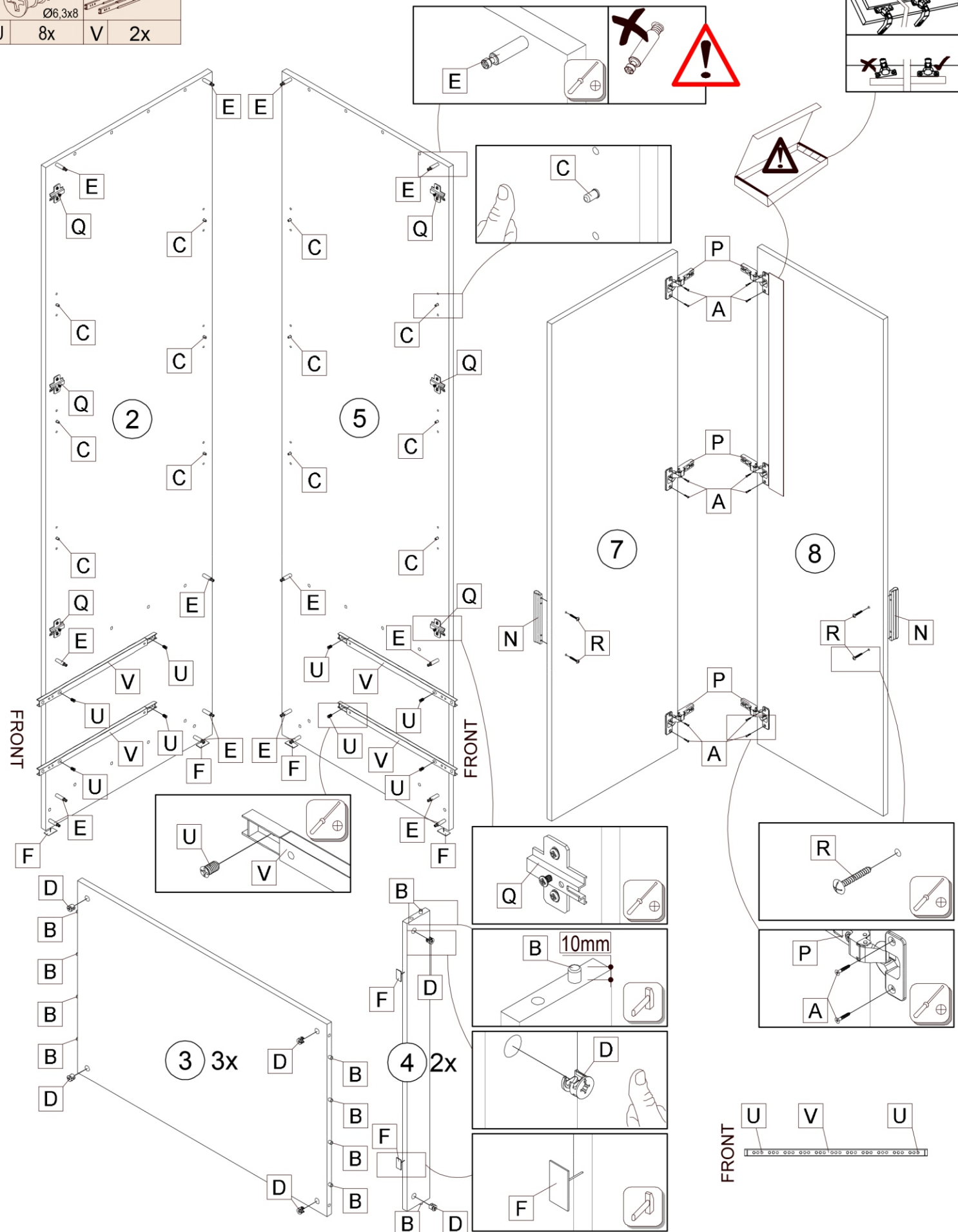

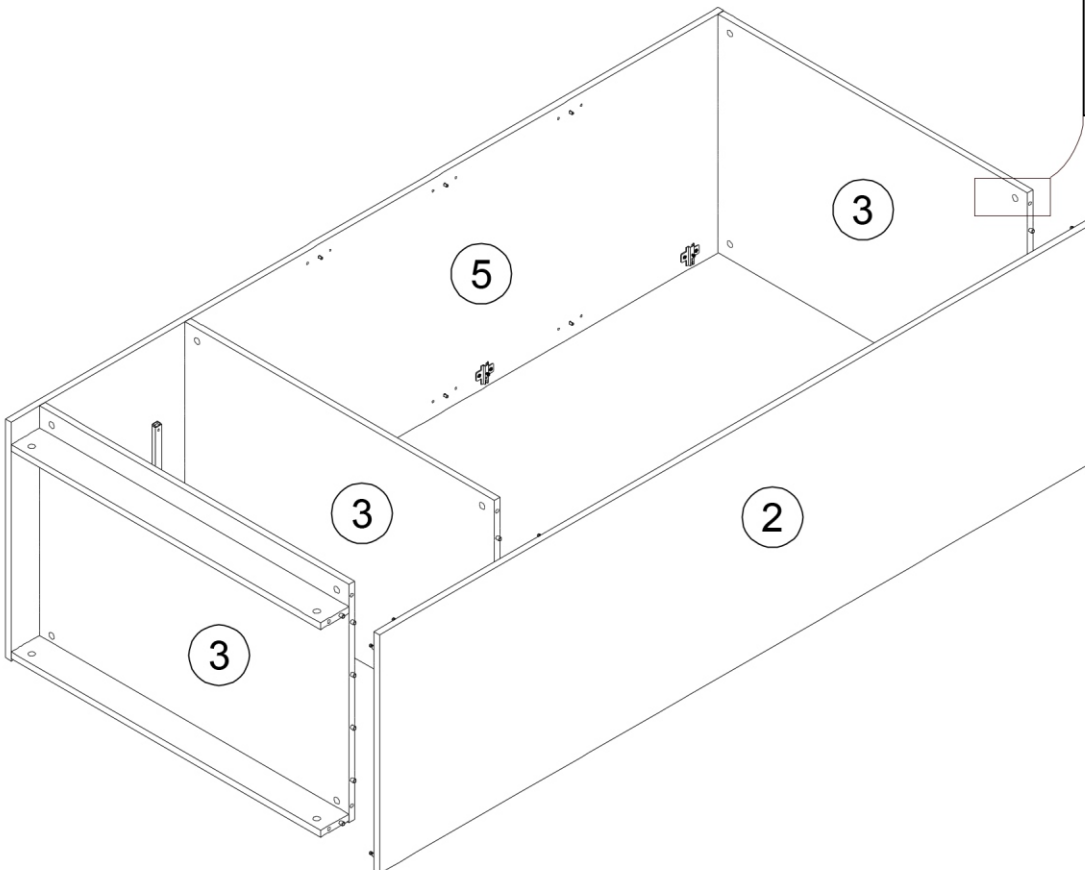
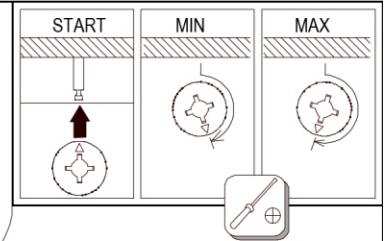
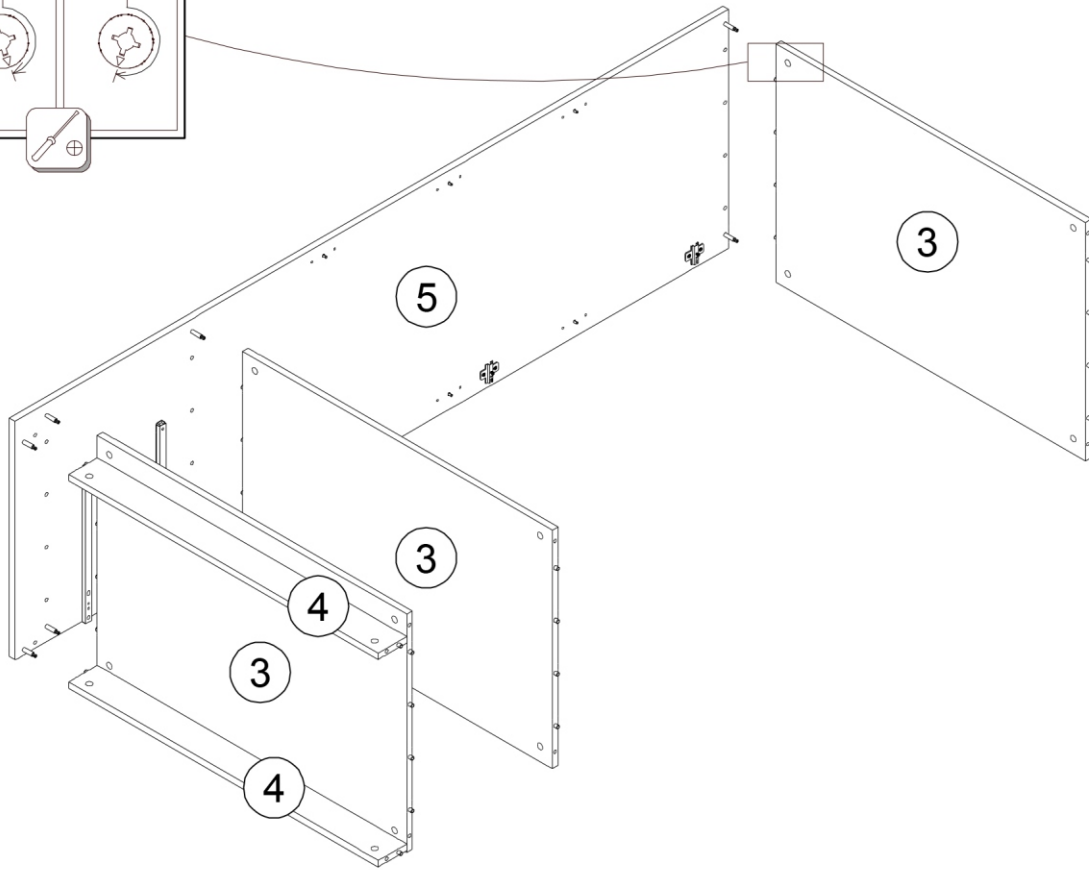
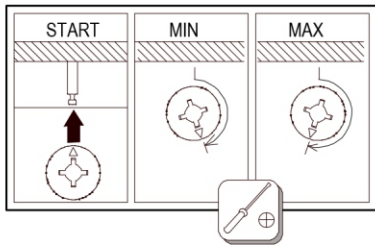

A 12x	B 28x	C 12x	D 16x	E 16x	F 8x	N 2x	P 6x	Q 6x	R 4x
U 8x	V 2x								



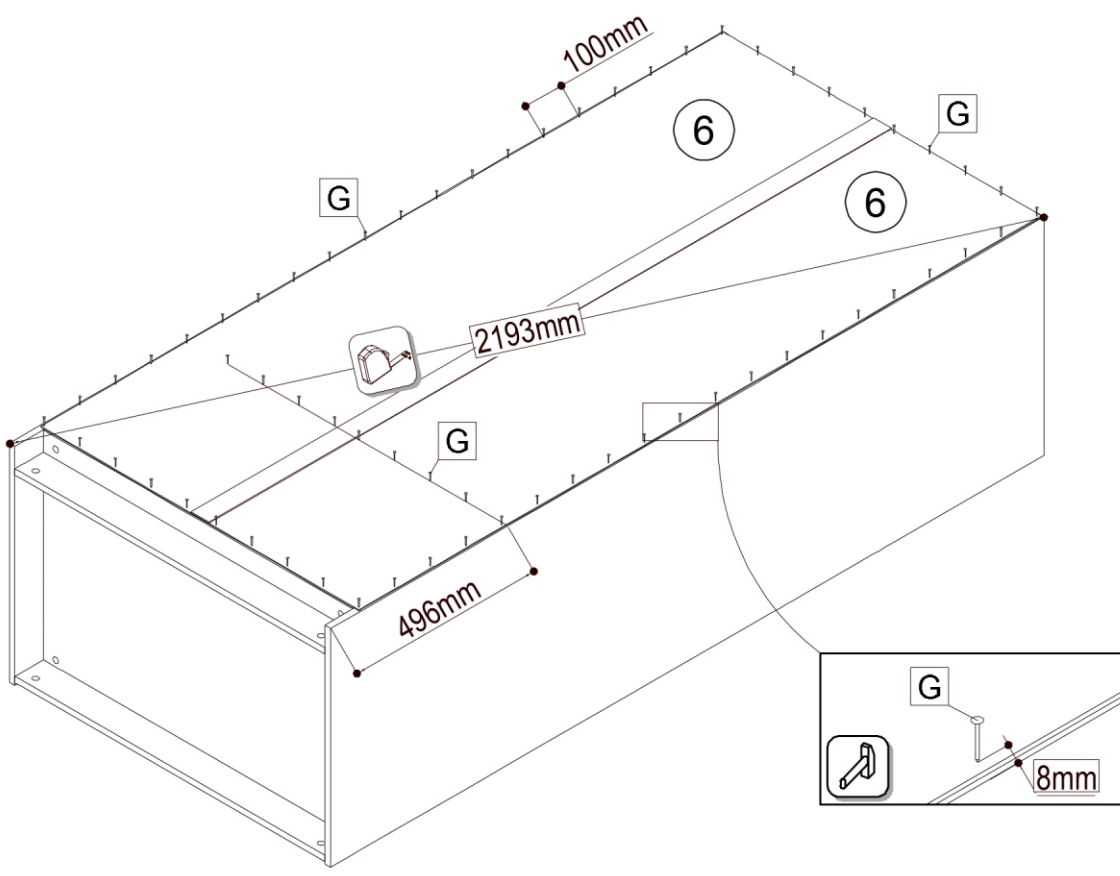

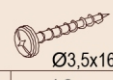

	Ø1,2x20
G	75x

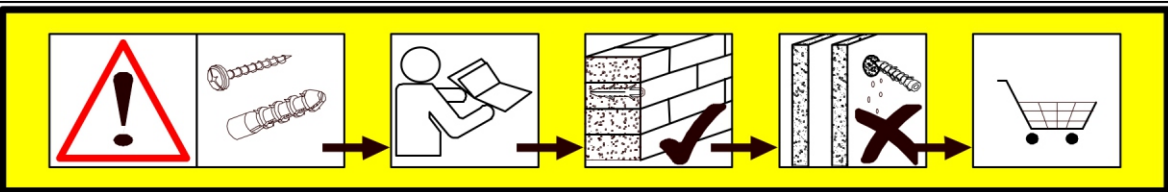

	1x		Ø3,5x16	16x
	1x		Ø8	Ø4x70
K	1x	L	1x	

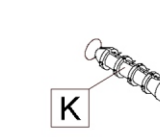
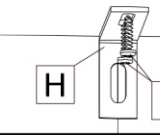
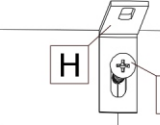

1.  v=1965
2.  Ø8
3.  K
4.  H J
5.  H L

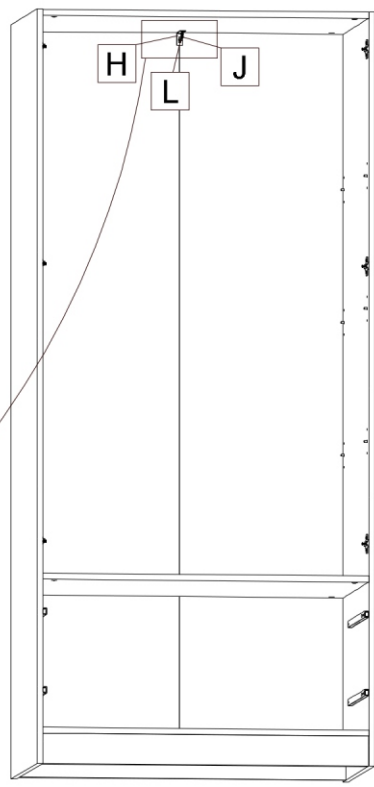







DE
Achtung! Die Wandbeschaffenheit ist vor der Montage unbedingt zu prüfen. Die beigelegten Universalkübel sind ausschließlich nur zur Verwendung für festes Mauerwerk wie Beton/Ziegel. Die Mauerdübel dürfen nicht bei Mauerwerk wie Hohlraumziegel, Leichtbausteinen, Gipskartonplatte oder anderer Rahmenbauweise verwendet werden. Bei diesen Mauerwerken sind gegebenenfalls Spezialdübel zu verwenden! Diese sind in einem Fachgeschäft (Baumarkt) erhältlich. Bei Nichteinhaltung wird seitens Produzenten/Händler und Importeur keine Haftung übernommen.

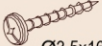

SK
Upozornenie! Pevnosť steny sa musí pred montážou bezpodmienečne skontrolovať. Univerzálne hmoždenky, ktoré sú obsiahnuté v balení, používajte jedine pre pevné murivo ako je betón/tehla. Hmoždenky sa nesmú používať v prípade ľahkého stavebného muriva, dutina tehla, u sádkartónových dosiek alebo iných konštrukcií rámu. U týchto murív je nutné použiť špeciálne hmoždenky! Tieto je možné dostať v špeciálnych predajniach so stavebným materiálom (stavebniny). Pri nedodržíaní pokynov nepreberajú výrobcovia/predajci a dodávateľia zodpovednosť za vzniknuté škody.

HU
Vigyázat! Szerelés előtt a falfelületet feltétlenül vizsgálja meg. A mellékelt univerzális tipli kizárólag stabil falazathoz használható mint például beton/tégla. A fali tipli nem használható könnyű építőkövek hez, üreg téglá, gipszkarton lapokhoz vagy más favázás építményekhez. Ezekhez a falfelületekhez csak speciális tiplik használhatóak, melyek szaküzletekben (barkácsáruházakban) beszerezhetőek. Fentiek figyelmen kívül hagyása esetén a gyártó/kereskedő vagy forgalmazó nem vállal felelősséget.

CZ
Upozornění! Před montáží je nutné zkontrolovat stav stěny. Přiložené univerzální hmoždinky jsou určeny pouze k použití pro pevné zdivo jako beton/cihly. Hmoždinky do zdi se nesmí používat u dutinová cihla, zdiva jako pórovitý stavební kámen, sádkartónová deska nebo jiný měkký materiál. U těchto zdív jsou nutné použít speciální hmoždinky! Jsou k dostání v speciálních prodejnách se stavebním materiálem. Při nedodržení těchto pokynů výrobce/prodejce a dovozce neručí za způsobené škody.

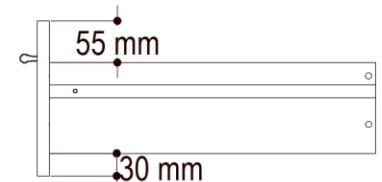
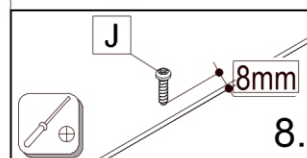
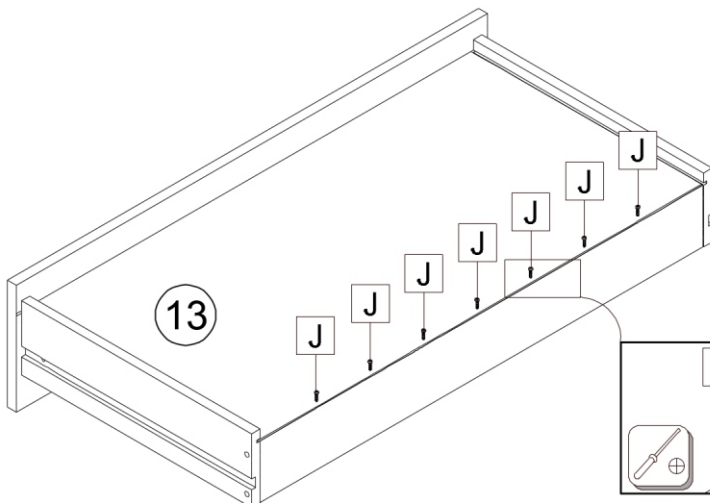
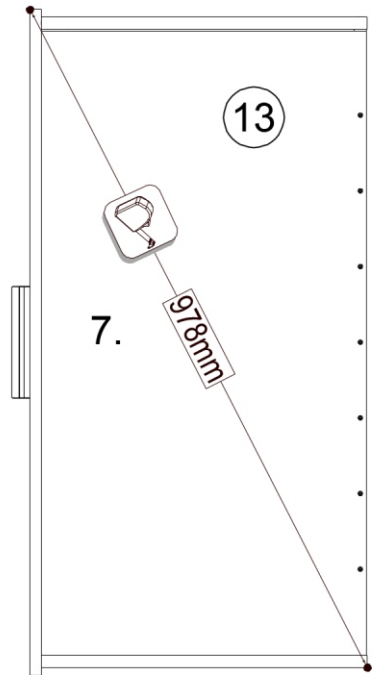
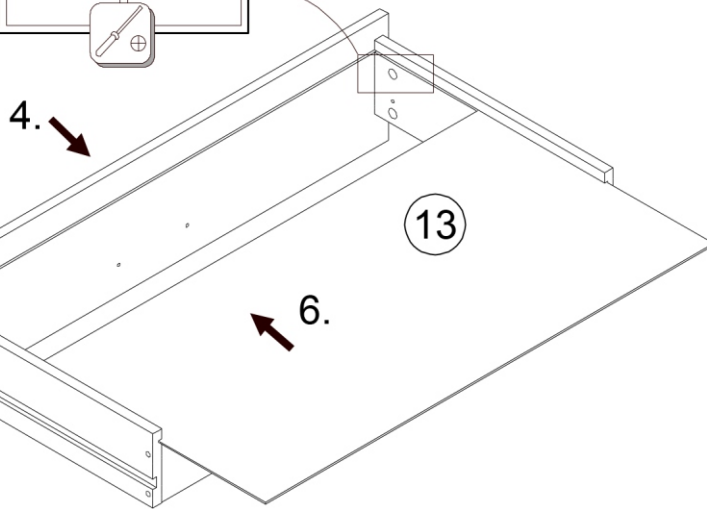
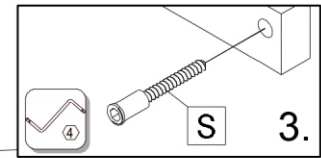
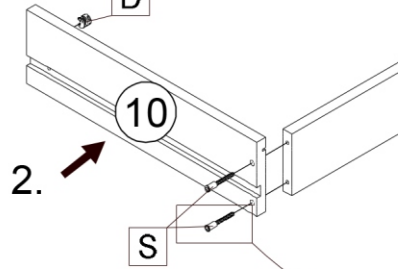
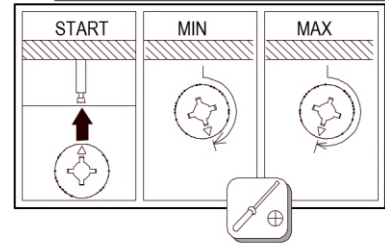
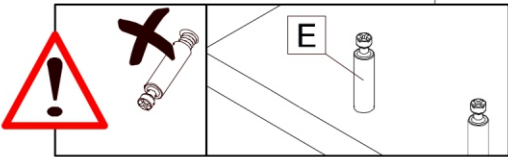
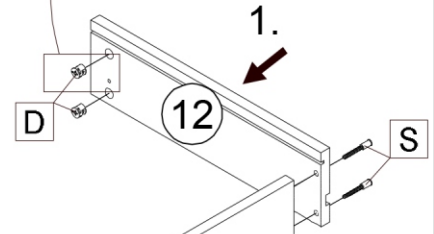
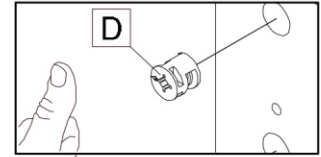
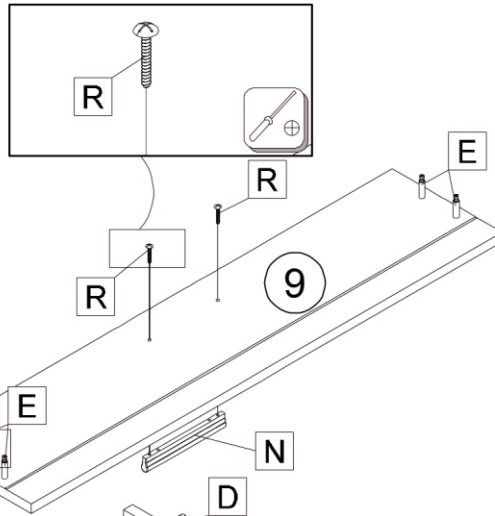
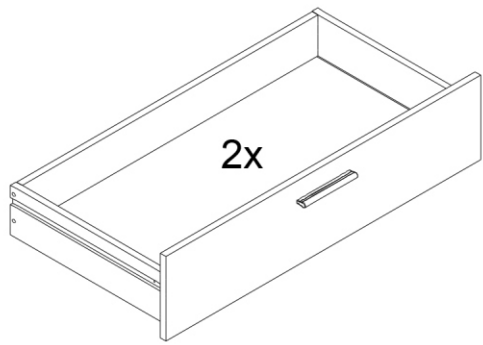
					
D 8x	E 8x	J 14x Ø3,5x16	N 2x	R 4x	S 8x Ø7x50



			M4x12
M	8x	T	4x

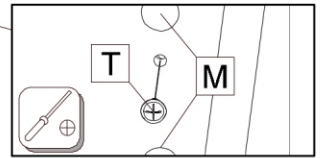
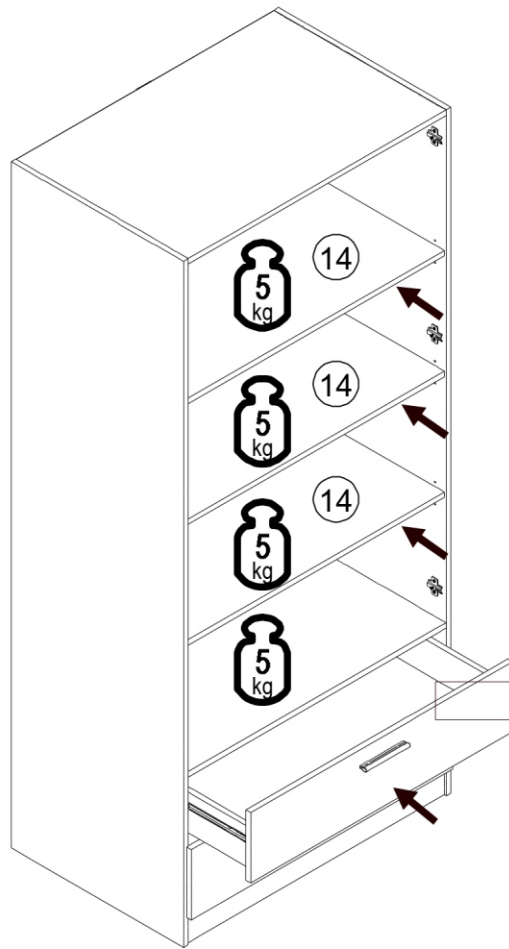

	
M	4x

